



AES

ADVANCED ENGINEERING SOLUTIONS

CORPORATE PROFILE



ENGINEERING AND CONSULTANCY SERVICES





TABLE OF CONTENTS

- 1 Vision, Mission & Corporate Values
- 2 Introducing AES
- 3 Resources & Expertise
- 4 Projects Experience
- 5 Projects Execution Approach
- 6 Registrations and Certificates





1 Vision, Mission & Corporate Values

OUR VISION

“Your Partner of Choice in Everyday Engineering & Consultancy”



OUR MISSION

We are committed to providing full services in engineering and project management solutions through

- ✓ Ingenuity of our talented team of professionals
- ✓ Knowledge and exposure to latest technologies
- ✓ Full knowledge of Agencies requirements & Regulations

OUR VALUES

- ✓ **Integrity**
“Consistently do the right things the right way, at the right time for the right reason”
- ✓ **Accountability**
“Commitment to accept responsibility”
- ✓ **High Performance**
“Consistently meet and exceed expectations with focus on continuous improvement”
- ✓ **Value our People**
“Treat our people with respect and dignity communicate with clarity and honesty, and provide them with growth opportunities in a pleasant culture”
- ✓ **Teamwork**
“Collaboratively work together to achieve our common goals”
- ✓ **Customer Commitment**
“Meet and exceed our customer expectations”





1 Introducing AES

Since
2012

Projects
+150

Staff & Experts
+60

Offices & Locations
+8

ADVANCED ENGINEERING SOLUTIONS (SG) PTE. LTD. (AES) is a registered corporation in Singapore, United Arab Emirates and Lebanon with offices, representatives and partners in Asia (Philippines), GCC (Saudi Arabia & Bahrain) and in the Middle East (Iraq & Turkey). AES corporate investments cover several fields: 1) Facilities Management, 2) Engineering Design, 3) Environment & Communities Services, 4) Real-Estate Development and 5) Transport & Logistics. This profile illustrates AES capabilities, experiences, and resources in the field of **Engineering and Consultancy Services** in various sectors and specialties.

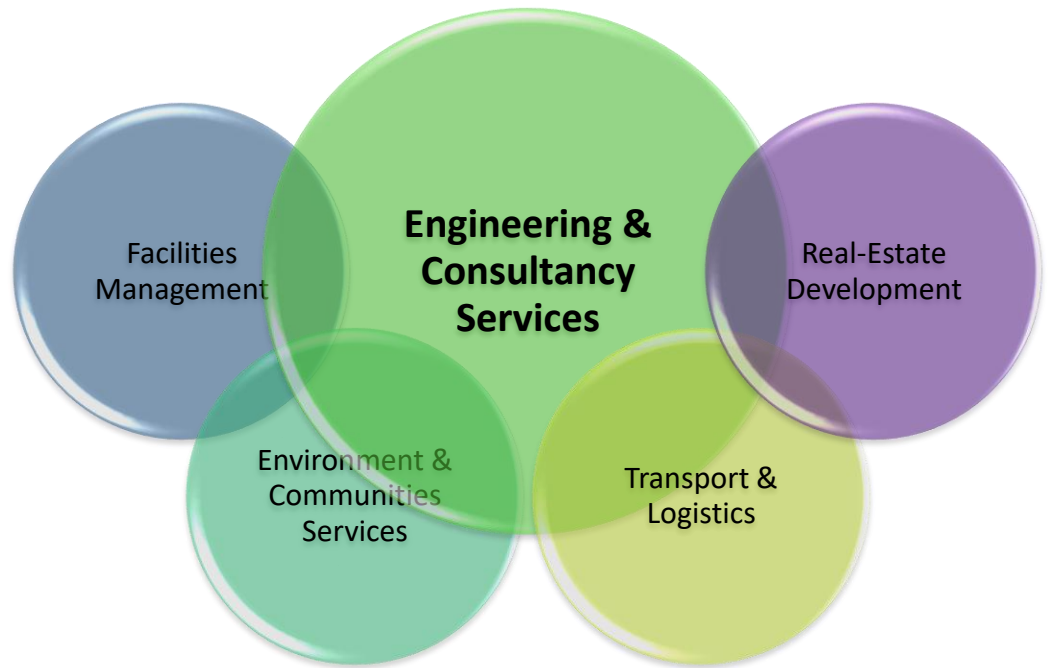

AES provides engineering design and consultancy services to main clients and to several international consultancy firms as a sub-consultant for major projects in addition to full engineering services to plants, businesses owners, construction contractors and local communities. The key specialties of expertise of which AES aims to provide unparalleled quality technical services and solutions cover:

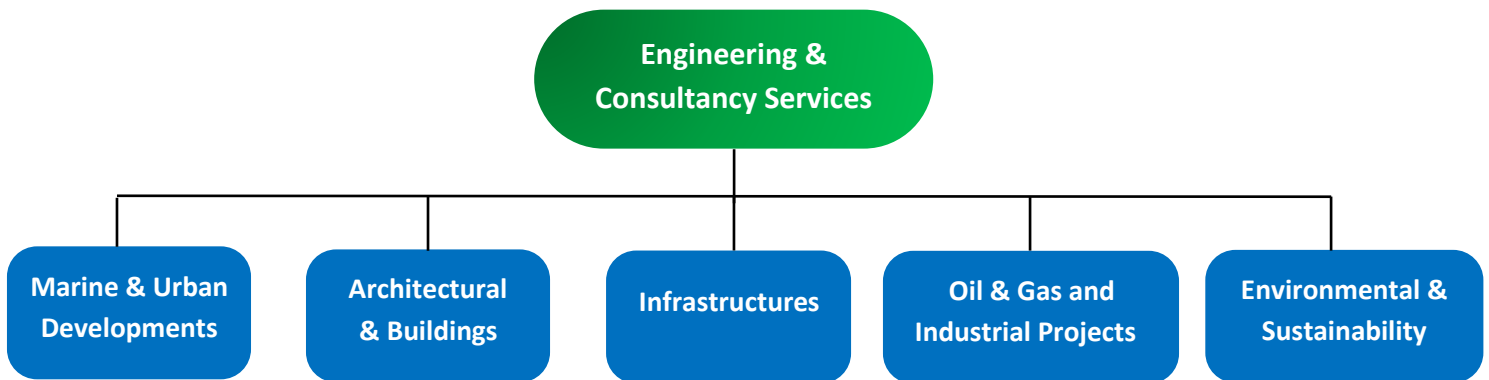



Offices & Contacts

- **AES Singapore:**



ADVANCED ENGINEERING SOLUTIONS (SG) PTE. LTD.

Registration No. **UEN: 202211632W**

Address: 8 Marina View #39-04 Asia Square Tower 1, Singapore 018960

Tel: +65 65422309 , +973 38942642. Email: info@sg-aes.com

- **AESP Philippines:**



V5 Building, Office No. 302-308 3rd Floor, Hernaez Cor. Carmen Street

Bacolod City, Tel: +63-344458210/+63-9085161509/+63-9457194592.

- **Middle East:**



AES UAE: SPC Free Zone – Sharjah, Tel: +971-561409403 , Kingdom of Saudi Arabia

Partner Office & Bahrain Representatives, Tel: +973-34007890 / +966-506539851



AES Lebanon: El-Koura – Kafr Aaqqa – Center Mitri, Tel: +961-3196240 /

+961-6651637/ +961-71814788 / +961-71062684. Email: info@aes-leb.com



AES Partner Office (Advance Engineering Consultant), Al-Yarmouk Street, Baghdad,

Republic of Iraq, Registration No. Baghdad-1345, Tel: +964-7850498524



Turkey Representatives: Gaziantep, Turkey – Contact - Tel +90 551 587 9600



AES Offices & Partners





3 Resources & Expertise

Blend of experience and expertise that is well suited to the demands of any project. Engineering resources in the Middle East and Asia supported by crew of designers, draftsmen and project support personnel. Our qualified resources on-site and in design/drafting offices provide substantial capacity to accommodate any size of fast-track and demanding projects.

Wide experience in auditing, assessing, evaluating, and design engineering of piping systems, fire protection, marine & port facilities, buildings, urban & land developments, and infrastructures using well recognized modelling tools (SAP-2000, CAESAR-II, PIPENET, BIM & Others).

- *Architectural & Buildings, Landscape & Urban Developments Design*
- *Hydraulic Modelling & Studies (PIPENET / PIPE-FLO)*
- *Pipe Stress Analysis (CAESAR-II) – Dynamic Modal Analysis*
- *Pipe Flow Design - Steady State and Surge Analysis*
- *Structural Modelling (SAP, SAFE, ETABS, SLOPE/W & Others)*
- *Fire Protection Design Review - NFPA Compliance*
- *HAZOP, HAZID and Risk Assessment*
- *Signal Transmission & Fiber Optic Design*
- *Telecommunication Design*
- *Instrumentation & Low Current Systems*
- *Traffic Studies / PTV Vissim Modelling*
- *Electrical Studies (ETAP, DIALUX & Lightning Risk Modelling)*
- *BIM Modelling Capabilities*
- *Facilities Fire & Safety Design - Egress Design & Emergency Plans*

Engineering Design

Project Feasibility Studies
Conceptual Design Development
Front End Engineering Design
Procurement Assistance
Bills of Materials & Cost Estimation
Preparation of Tender Documents
Projects Contracting Strategy
Bid Stage Engineering Support
Design Review
Detailed Engineering
Existing Structures Evaluations
Design Completion / Adjustment

Project Management

Client Representation
Project Management
Vendors Selection Assistance
Project Startup & Setup Systems
Project Control
Governance

Technical Support

Shop Drawings
Site Conditions Assessments
As Building
Preparation of Procedures & Methodologies
Inspections
Quantity Surveying
Claims Support & Management
Design Verifications
Alternative Value Designs
Logistics & Erection Studies
Clashes Resolutions





4 Projects Experience

AES have executed and delivered quality engineering work and services to prestigious clients with more than +150 projects carried out between years 2015-2025 in KSA, UAE, Iraq, Bahrain, Kuwait, Philippines, and Lebanon as directly engaged consultant in charge by clients or as sub-consultant with other affiliates. AES provided specialty technical services in the fields of Marine Engineering, Fire Safety, Process Engineering, Traffic Modelling using PTV Vissim, Structural & Geotechnical Modelling, Electrical Modelling using ETAP, DIALUX & other and Transport/Logistics Consultancy. AES developed proven experience in design and detailing of Railway & Roads Infrastructures with several EPC projects executed with main construction contractors and international consultants.

AES provided Architectural concepts and designs for several clients including personalized private villas, architectural programming and concepts for prestigious buildings, residential buildings, special needs and industrial functions buildings and facilities. In addition, AES has invested in the real-estate sector and developed several high-quality residence projects in addition to contracts and engagements in facilities management and private communities' services. Projects experience highlights and list are provided in this profile in accordance with the AES main fields of expertise.

5 Projects Execution Approach

AES follows the task force approach on which a dedicated *Project Manager* is assigned for each project who will assemble a team of expertise and resources to ensure project delivery. AES has the capacity to deploy resources to be on-site for Data Collection, As-Building, Engineering Coordination and providing short or long terms technical support in client's offices and project sites. AES hubs for carrying out engineering design and drafting are located in several countries, strategically positioned to serve wide range of projects and clients and provide local support and representation to **International Consultants and Contractors** within short notice including **GCC Countries, Asia (Singapore, Philippines) and the Middle East (Lebanon, Iraq, Syria & Turkey)**. AES ensures quality engineering by employing the latest design and modelling tools and carrying out rigorous checking and verification processes with trained team in *ISO-9001* procedures.

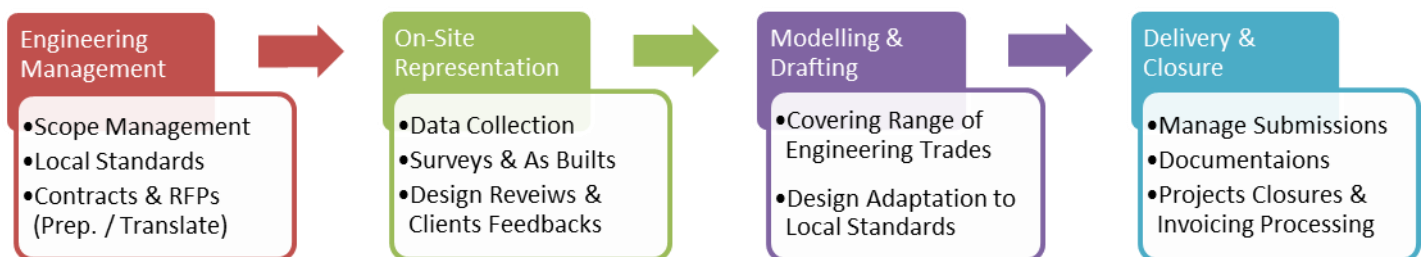

6 Registrations & Certificates

AES is legally registered entity in Singapore, UAE and Philippines and **ISO 9001:2015 Certified**. Registration and legal documents and certificates are attached to this profile for reference.



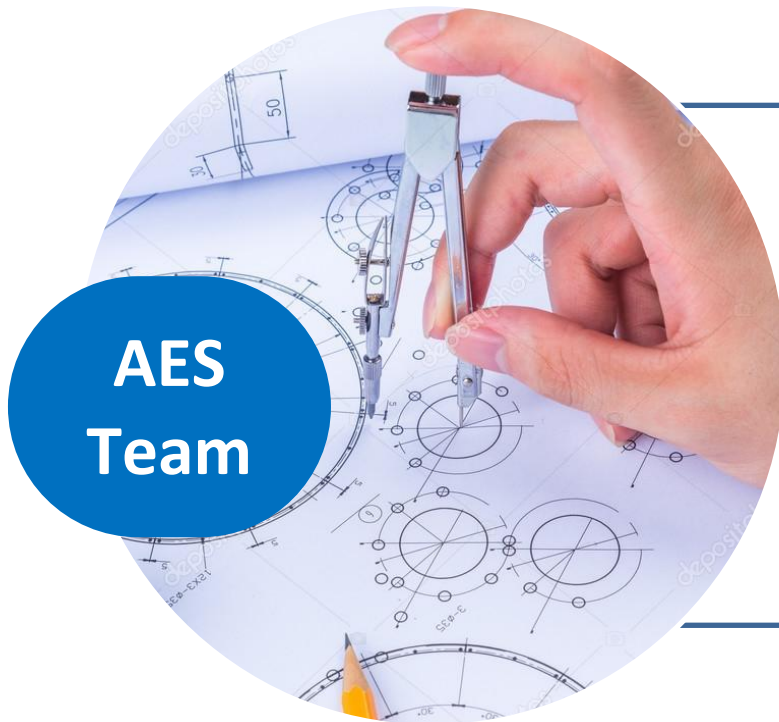

Asia, GCC & Middle East



Multi-Discipline Engineering Staff



Field Technical Support





Key Resources

Hussam Kassab (Engineering Manager)

BSc. Civil Engineering, Project Management Professional - PMP® , NFPA - CFPS

Over (35) years engineering, design, consultancy, engineering support and management experience. Extensive experience in multi-discipline technical environment related to Oil & Gas and Infrastructures, (Petrochemicals, Desalination, Bridges / Causeways, Railways, Terminals, Ports & Berths and Marine Structures). Proven experience in design concepts development, master planning, detailed engineering, statutory reviews and approvals and environmental issues. Main systems/equipment sizing and logistics considerations. Preparation of technical studies, engineering design, concepts developments, front-end engineering and RFP's preparations for PPP transactions as technical advisor and major EPC projects.

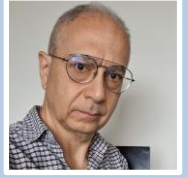

Bern Minada (Senior Architect & Master Planner)

BSc. Architecture, Member, United Architects of the Philippines

Over (30) years engineering and design on wide range of master planning and architectural projects. Enhancing the technical aspects for standard and LEED requirements. Planning, programming and design of functional and aesthetics for Urban Developments and buildings with various groups of occupancies including Industrial Buildings, Houses, Dwellings, Offices, Hotels, Hospitals, Medium Rise and High Rise Buildings.



Reem Hayder (Process Engineer)

MSc. Chemical Engineering – BSc. Chemical Engineering

Experience in preparation of key process deliverables including P&IDs, PFDs and piping main arrangements. Design and engineering of Water Treatment systems, Oil & Gas facilities, utilities systems ...etc.... Coordination with Piping/Mechanical, Instrumentation and Electrical design teams. Knowledge of preparations of project's documents, BOQs and specifications.



Mario Castrillo (Senior Instrumentation & Low Current Systems Engineer)

BSc. Electrical Engineering - Electronics Major

Over (28) years accumulated engineering & designing of Instrumentation and control for Oil and Gas Refinery, Petrochemical Plants, Downstream/Upstream Pipeline and Water Desalination Plants. Instrumentation control and monitoring for Distributed Control System (DCS), Emergency Shutdown System (ESD), Vibration Monitoring System (VMS), Boiler Management System (BMS), Programmable Logic Controller (PLC), Compressor Control System (CCS), Fire and Gas System (FGS), Remote Terminal Unit (RTU), Radar Tank Gauging System (RTG), Power Monitoring System (PMS), Flow Metering System (FMS) and others.



Jose Togado (Senior Mechanical Engineer)

BSc. Mechanical Engineering

Over (25) years years of combined experience in design, engineering and construction (management, execution, quality, design familiarization and related engineering standards) for major buildings, facilities and plants including Utilities Systems (HVAC, Fire Protection, Water Systems), Operation and Maintenance of Steam Generators with its auxiliaries and other industrial equipment and machineries for a sugar manufacturing plant and District Cooling Facilities.





Cezar Pagharion (Senior Electrical Engineer)

BSc. Electrical Engineering, Western Institute of Technology

Over (34) years diverse electrical design and engineering experience relating to petrochemical, gas and oil refining, high-rise buildings and offices associated with electrical design and supervision. Expertise covers design of 230Kv, 115kv & 69kv, switchyard and substations, overhead transmission and 13.8Kv distribution line, electrical power distribution system, power system protection, technical load evaluation, equipment sizing. Power System Analysis using ETAP PowerStation Software. Relay and Circuit breaker protection coordination study using Power Plot software. Conceptual (FEED) and Detailed Designs, technical specifications with thorough involvement in SAUDI ARAMCO and other SABIC projects.



Mustafa Hussain (Principal Structural Engineer)

BSc. Civil Engineering

Over (10) years experience in structural engineering design and modelling using SAP-2000, ETABS, SAFE and others. Static and dynamic analysis of railway and highway bridges, industrial facilities, buildings, deep foundations, pipe and box culverts, water retaining structures and high-rise buildings. Preparation of detailed design drawings, shop drawings, BOQs and projects specifications. Participated in wide range of projects in Saudi Arabia, Turkey and other locations in the middle east. Experience in modelling and detailing in BIM.

Ghadah Kassab (Traffic Modelling & Logistics Planner)

MSc. Transport Engineering and Planning – UWE, Bristol, UK , BSc. International Logistics

Experience in traffic planning and analysis of logistics and transport requirements for logistics hubs and urban and industrial developments including supply chain resources, analysis of linear & high-volume materials construction projects and design of transportation infrastructures, traffic management systems and enhancements of operational efficiencies. Capabilities in traffic simulation and modelling using PTV-VISSIM and worked on several major transport and traffic infrastructure-based projects.

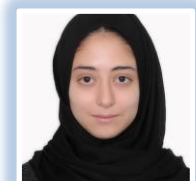

Glaiza Espinoza (Design Specialist)

BSc. Information System

Design Assistant for master planning, marine & general engineering projects. Working with design team and principal engineers for development and detailing of project's deliverables including 2D & 3D rendering and generation of various views, conceptual design and detailing and setting up drawings drafting systems and controls. Experience in adjustments and production of CAD drawings for changes and modifications.

Ariane MaeDorego (Lead Civil Engineer)

BSc. Civil Engineering, Philippines

Dedicated and highly skilled civil engineer in modelling, drafting and detailing of wide range of projects including housing projects, buildings, oil & gas facilities and infrastructures. Preparation of detailed design drawings, shop drawings, BOQs and projects specifications. Participated in wide range of projects in Saudi Arabia, Qatar, Philippines and other locations in the middle east. Experience in modelling and detailing in BIM.

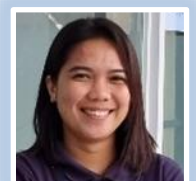



Projects Experience



Marine & Urban Developments



Architectural & Buildings



Infrastructures

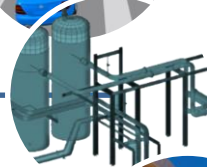

Oil & Gas and Industrial Projects



Environmental & Sustainability



Marine & Urban Developments

Highlights

Tharwa Town Marine Works, Saudi Arabia

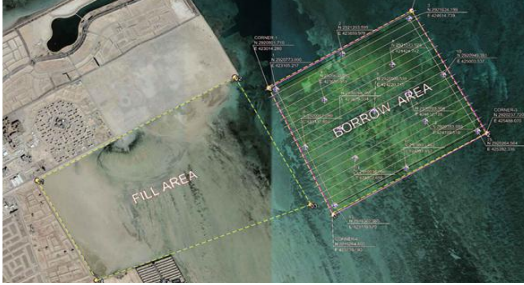

Marine reclamation works and shore protection design package for 4,400,000 m² land development (Tharwa Town). Preparation of bid package, contract documents, administration of tender stage and technical support during execution of reclamation works (2016 - 2018).

Concept Master Plan for New Island-A - Saudi Side, KFCA Saudi Arabia



Preparation of concept master plan for development of the Saudi-Side New Island as commercial and entertainment hub.



Uqair Area Development Company, Phase-1 Land Preparations & Marine Works Development, AlUqair, Saudi Arabia



Design and preparation of tender package for land preparation and marine works including topography, geotechnical, marine structures and marina basin, hydrology review, logistics requirements and project master schedule.

Marine & Urban Developments

Cornish Al-Khobar Development Marine Works & Infrastructures, Saudi Arabia



Design of reclamation, shore protection and ground improvement for +3,000,000 m2 new development with planning for infrastructure



Entertainment Development

Concept Master Plan for Proposed Muzahmiya Complex



Preparation of concept master plan, zoning and phasing plan for a proposed development as commercial and entertainment hub in Muzahmiyah, near Riyadh City. The project involved several innovative space design.

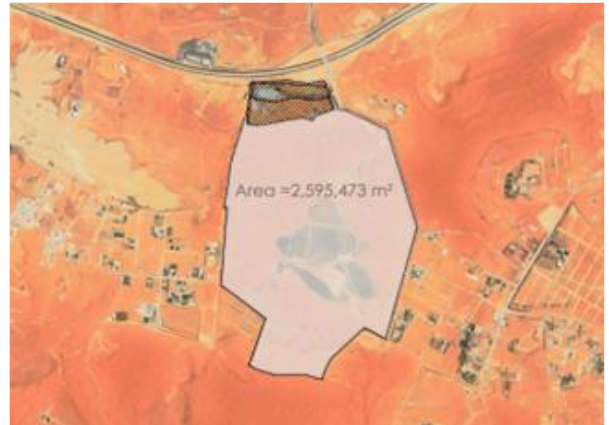

Landscape & Irrigation

Design of Landscape & Irrigation Systems for Land Borders Customs Areas, Saudi Arabia

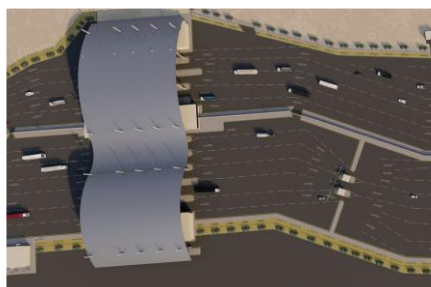

Design of landscape and irrigation systems for Saudi Arabia Land Borders Areas (Halat Ammar, Salwa, Al-Batha and Al-Khafji)





Architectural & Buildings

Architectural Concept for King Salman Reservation in Tubaig Saudi Arabia

Ground Floor Plan

Interior Look & Feel

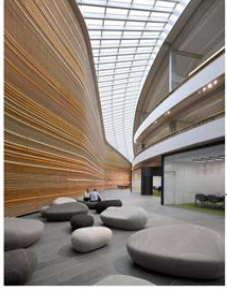

Natural Environment Colors and Materials

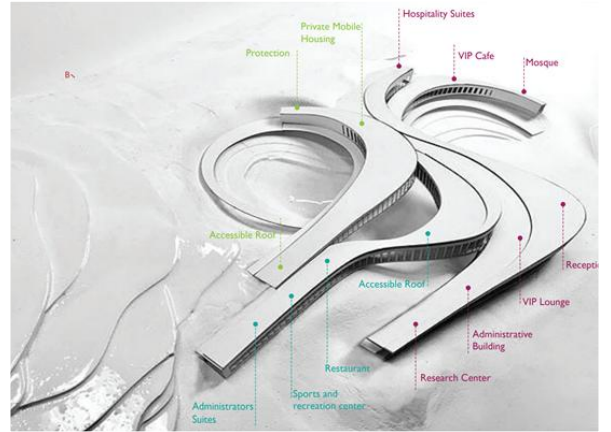
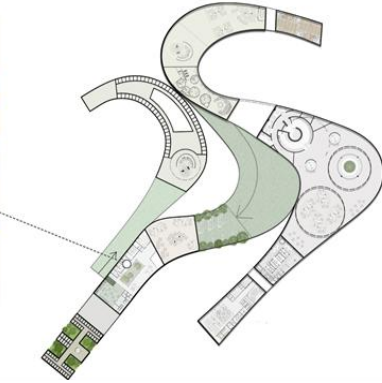

Preparation of master plan and architectural design concept and theme for a prestigious project including HQ building and facilities required for King Salman Reservation in Tubaig.

North Hills Residence

Design & Development of Luxury Holiday Apartments & 8-Villas Resort - North Lebanon



Design, construction and full scale development of luxury apartments and villas in North Lebanon with landscape & interior design

Innovative Buildings

Design of Olayan Business Park Complex Buildings (BIBP) - Riyadh, Saudi Arabia

Preparation of structural design modelling and detailing for Al-Bustan Innovation Business Park. Large Project with over 55,000 m2 of built-up areas including offices, management HQ center, multi-story parking spaces and other facilities.



Architectural & Buildings

Specialty Building

*OXAGON Terminal Main Warehouse Structural Modelling
NEOM, Saudi Arabia*

Preparation of structural modelling for technical design proposal of OXAGON Terminal, specialty building (L=500m, W=450m, H=85m).

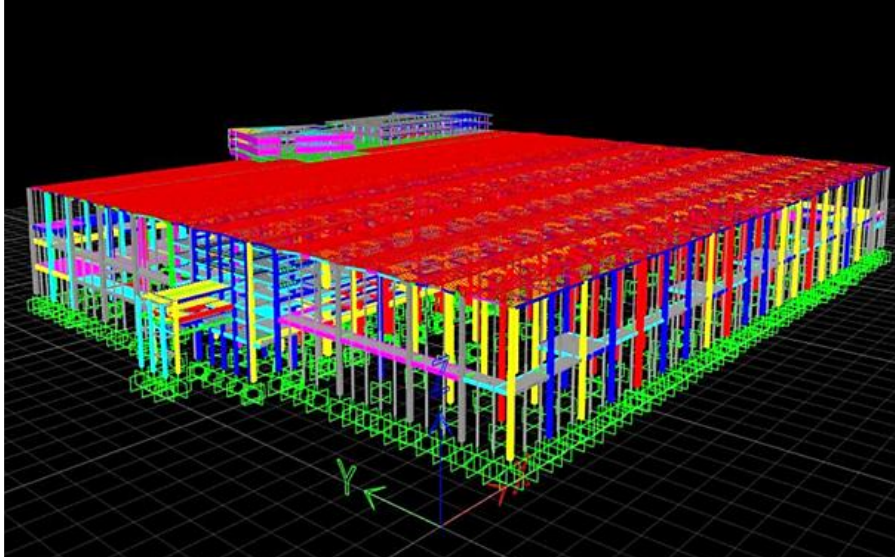

Structural Assessment & Buildings Reinforcement

Saudi Telecom Company, Exchange Buildings, Saudi Arabia

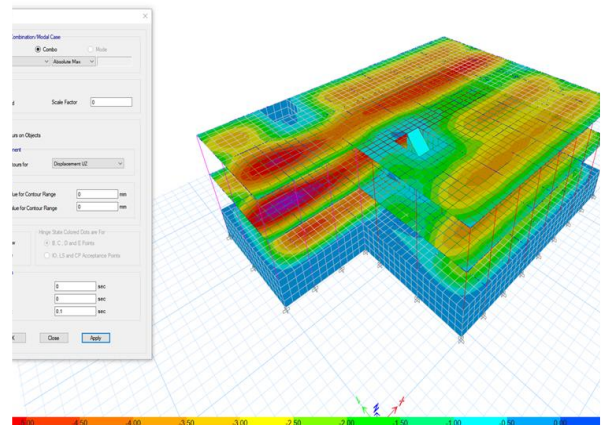

AES carried out structural assessment for more than (40) Exchange Buildings for Saudi Telecom Company including concrete repairs and structural strengthening design and supervision.

Buildings Projects Cost Engineering

Makkah Courts Complex Buildings, Cost Engineering Support - Makkah, Saudi Arabia

Preparation of BOQs, materials specifications, tender design support for a major building complex in Makkah with extensive MEP systems. Project included review and development of architectural finishing drawings, Fire & life Safety plans in addition to structural and earthworks materials take-offs.

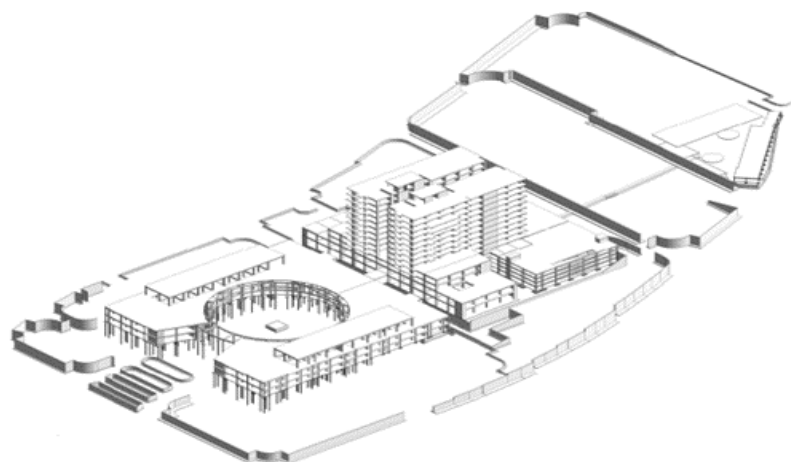



Architectural & Buildings

Rehabilitation of STC Muzammah Al-Balad Exchange Complex
Jeddah, Saudi Arabia

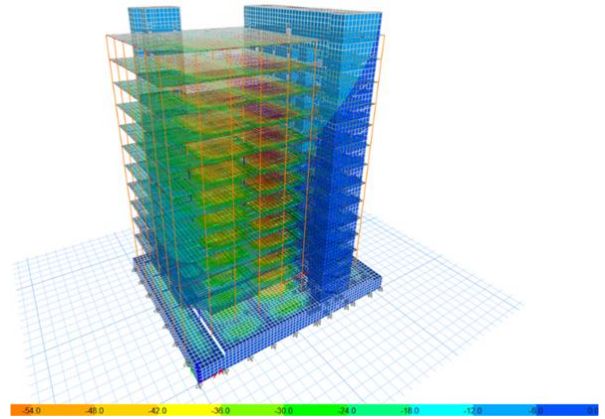

Design and construction supervision of rehabilitation works for main STC Exchange Building in Jeddah, Kingdom of Saudi Arabia, including analysis and structural qualification.

Public Education Buildings

Homs City Vocational Training Center, Homs City, Syria



Preparation of complete detailed engineering (Architectural, Structural & MEP) of new Vocational Training College (1200 Tenants).



Offices Buildings

HQ Office - BCI Hydrochloric Acid Synthesis
Jubail, Saudi Arabia

Detailed design of HQ offices for the new BCI plant complex in Jubail including interior design, 3D rendering and supporting facilities. Project included development of architectural, structural, MEP systems, finishing and furniture drawings and fire & life safety plans in addition to earthworks materials take-offs.



Infrastructures

Transportation & Traffic Modelling

Traffic Modeling for Border Island Expansion KFCA, Saudi Arabia - Bahrain

Preparation of complete real-time traffic modelling for passengers and cargo vehicles movements using software PTV-VISSIM. The new expansion project is planned in 2-Phases, 2500 Veh./Hr. and 4000 Veh./Hr.



Railway Engineering

Sand Mitigation Study for Dammam-Jubail Railway Line, Saudi Arabia

Preparation of complete sand mitigation design report for the new railway line connecting Dammam and Jubail (CTW-120 Project), including modelling of sand accumulation along the alignment (segment-by-segment), development of sand risk models and design recommendations of countermeasures with maintenance and operational planning.



Bridges Engineering

Design of Bridges & Culverts for Al-Jouf - Al-Qurrayat Railway Line Saudi Arabia

Preparation of complete structural design and shop drawings of Wadis crossings along Al-Jouf - Al-Qurrayat railway line including dynamic and static modelling of bridges to sustain High-Speed-Rail loads according to Eurocodes.

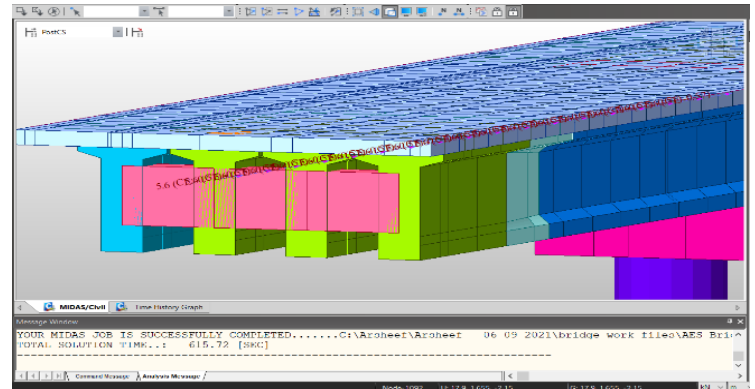
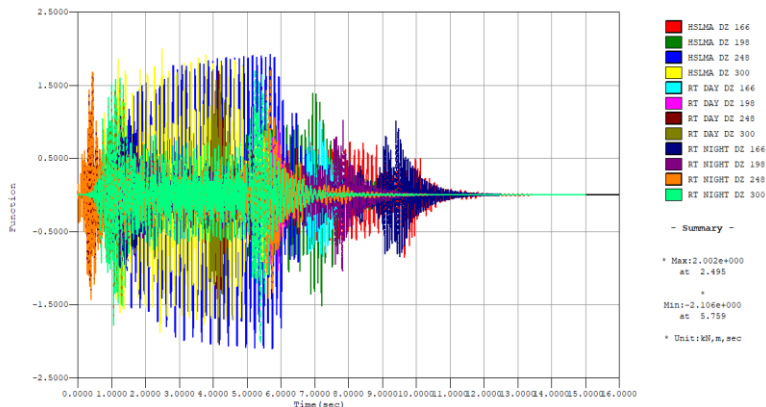



Infrastructures

Railway Depot

NEOM Depot Tracks & Alignment Design, NEOM, Saudi Arabia

Preparation of complete technical design proposal for tender of NEOM Railway Depot including tracks, alignment, tracks slabs, RHEDA2000 and VP slabs option, earthing design, layouts and BOQs.

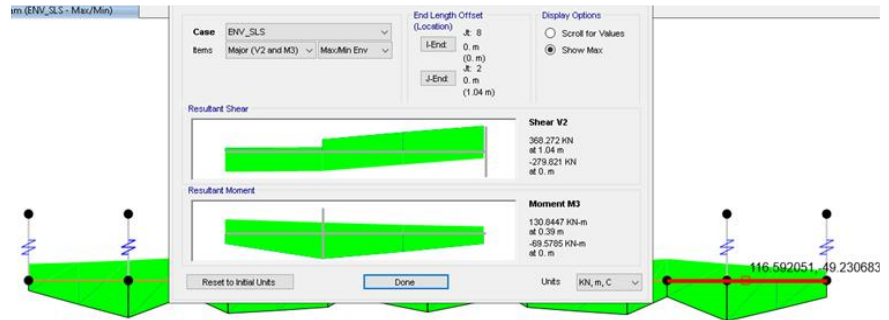

KHZM Pipeline Deep Excavation Stability Modelling & Design, Saudi Aramco, Saudi Arabia

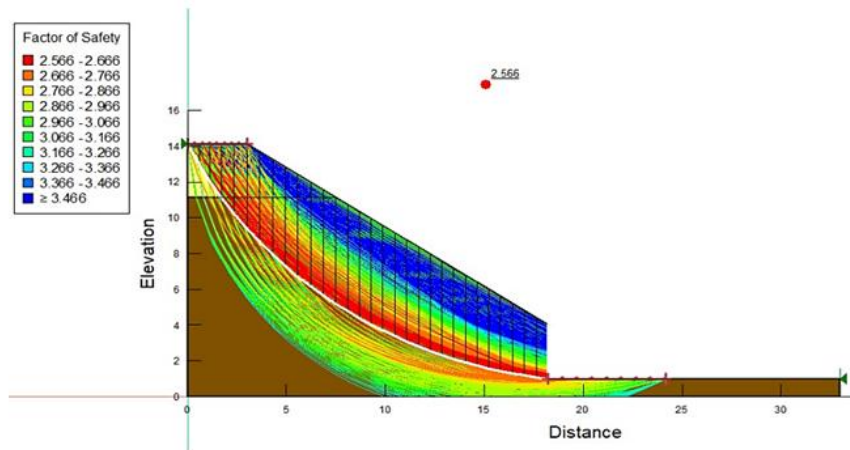

Modelling and design of slope stability for deep excavation of major KHZM Gas Pipeline (120 km) for Saudi Aramco project in the southern area. Work involved modelling using Slope/W and stability design solutions.

Railway Bridges Structural Assessment

Hofuf Railway Bridges Structural Appraisal, Saudi Arabia

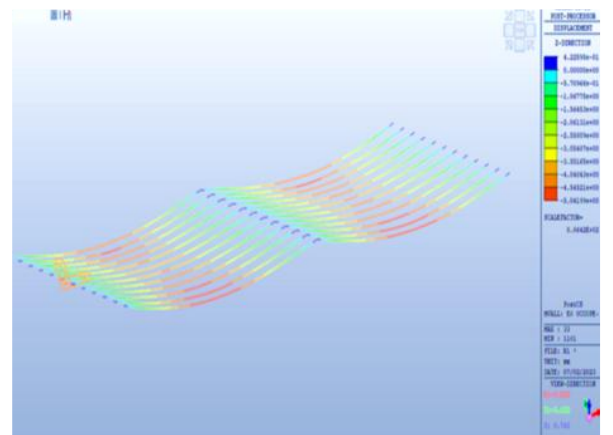

AES carried out structural assessment and design check for pre-stressed railway bridges of Hofuf railway line for SAR. Work included modelling of actual girders and foundations conditions.





Oil & Gas and Industrial Projects

*BCI - Hydrochloric Acid Synthesis Plant
Bertram & (U-LUM) Process Units, Saudi Arabia*

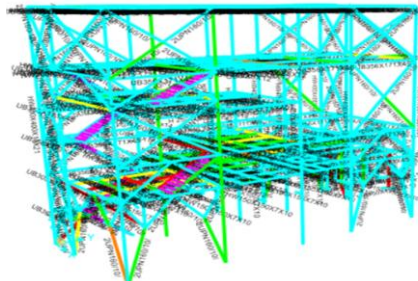

Hydrochloric Acid Synthesis Plant, preparation of detailed engineering including process requirements review, structural, mechanical and electrical design for three (3) process buildings including stacks and associated LPS protection. (2019 - 2020).

Hydraulic Modeling for Firewater, CAT, GCC Saudi Aramco Camp Facilities - Saudi Arabia

Preparation of hydraulic modeling using (PIPETET PIPE-FLO) - fire protection systems, cross loop network analysis for several Saudi Aramco camps facilities.

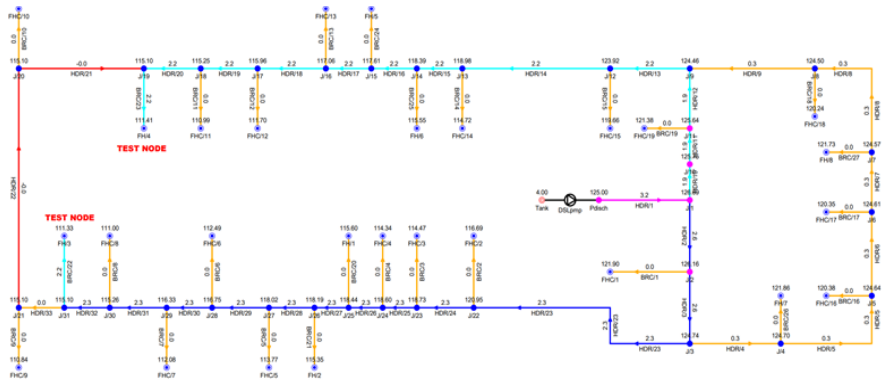

Heat Flux Radiation Modeling for Burn Pit, GCC, UTFG-6 Pipeline – Saudi Aramco, Saudi Arabia

Preparation of process calculations for estimation of heat flux on nearby equipment to pipelines burn pits and design of suitable radiation shield walls.

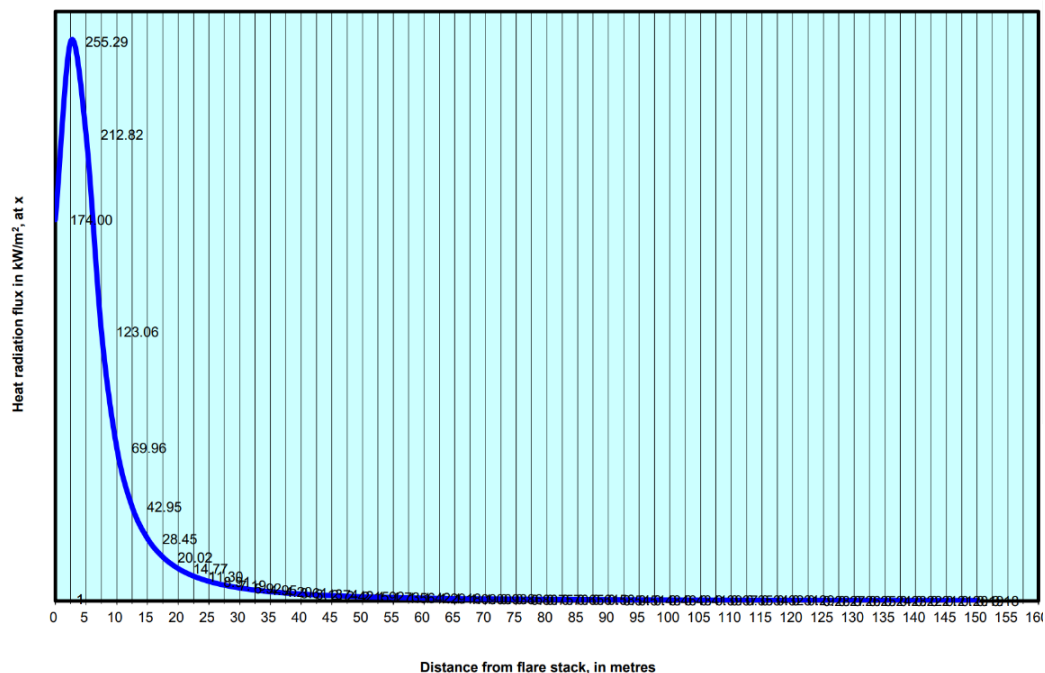



Oil & Gas and Industrial Projects

*Saudi Pallets Manufacturing Company (SPMC)
Plant Expansion, Saudi Arabia*

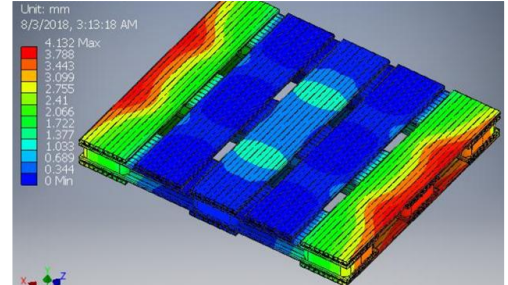

Detailed design for Roto-Molding technology plastic Pallets manufacturing plant in Dammam 2nd Industrial City including process equipment setting, cooling system design, E&I systems and civil/structural works. Preparation of tender documents, shop drawings and construction supervision. Stress Modelling of product pallets under racking and packaging loading cases.

Pipe Stress Analysis (CAESAR-II) - Dynamic & Vibration Modal Analysis – Several Projects, GCC/CAT & Others -Saudi Arabia

Perform Pipe Stress Analysis by (CAESAR-II) for several pipelines and process equipment installations for various plants and pipelines project. 3D Modelling of piping and equipment arrangements.

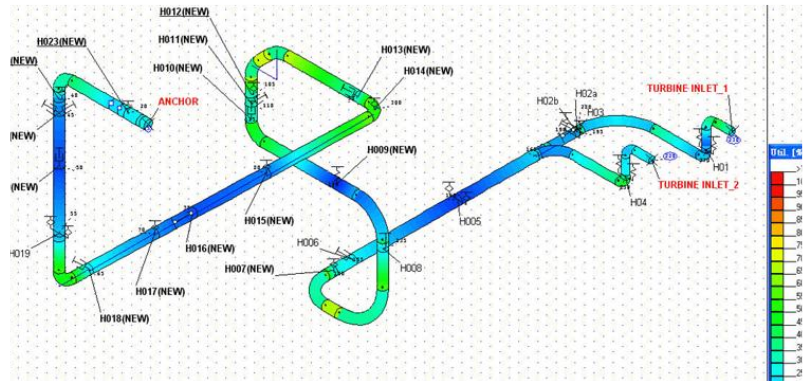

Zuluf Saline Water Treatment Plant Preliminary Design & Technical Support Oil Field Water Injection (800,000 BPD), Saudi Aramco, Saudi Arabia

Prepare process & plant facilities design including saline water process packages, piping and facilities for technical proposal and financial cost estimates required for Saudi Aramco PPP tender. Work involved preparation of complete plant conceptual design and engineering in association with Veolia Water Technologies.

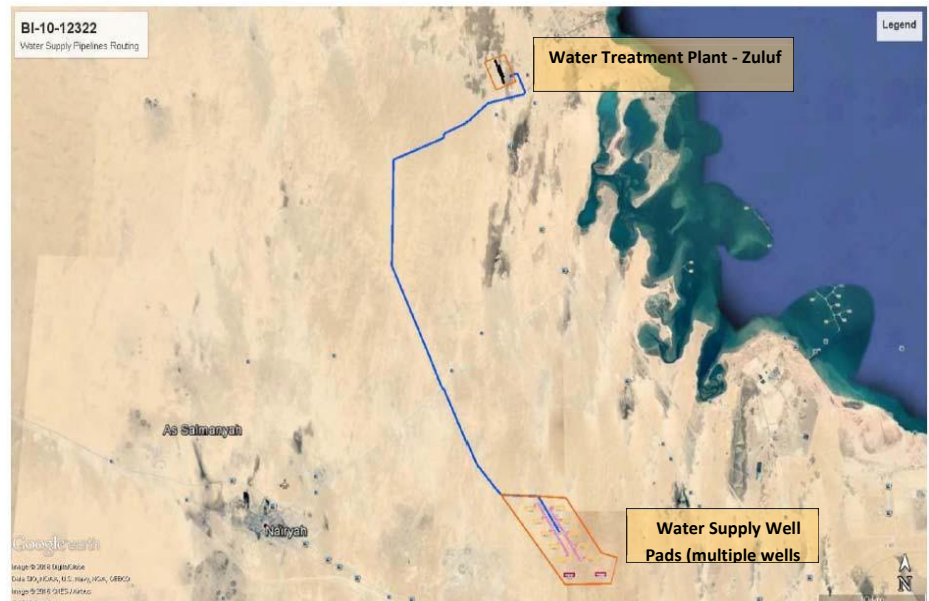



Environmental & Sustainability

Design and Supervision of Nour Village for Special Needs Residents, Syrian Refugees Border, Kuwait Support



Preparation of master plan, detailed design of residential units and infrastructures and construction supervision for new village of 250-residential units including solar power provisions and supporting buildings and facilities. Design features and facilities for residents with special needs (lost vision).

Waste Management

Conceptual Design of GSW & IHW Waste Plant for OSCAR Project, Saudi Aramco, Saudi Arabia

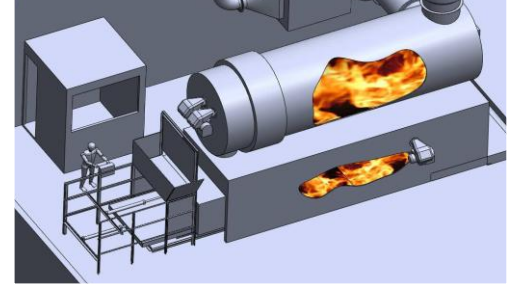

Concept layouts, infrastructures, utilities and facilities for new Saudi Aramco - Veolia plant (OSCAR Project) for GSW and IHW.

Groundwater Remediation

Design & Pilot Testing of Ground Remediation System Utilizing Air Sparging, PetroKemya, Saudi Arabia

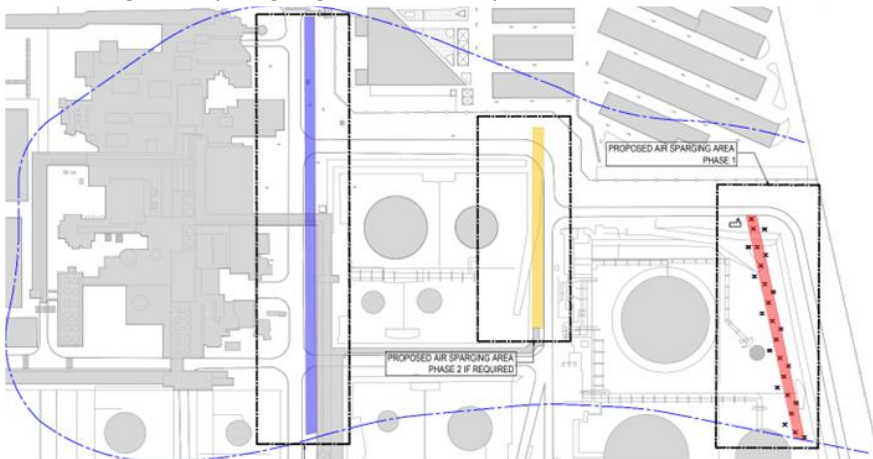

AES scope included design, installation and operation of Test Pilot system to examine influence zone and system effectiveness and preparation of design and tender package for the full-scale Ground Remediation Treatment System for Petrokemya (3-Phases). AES partners with ARM Associates for environmental consultancy.





Waste Management

Engineering Services for Dubai Municipality Dump Sites
Environmental Closures & Re-shaping. Dubai, UAE

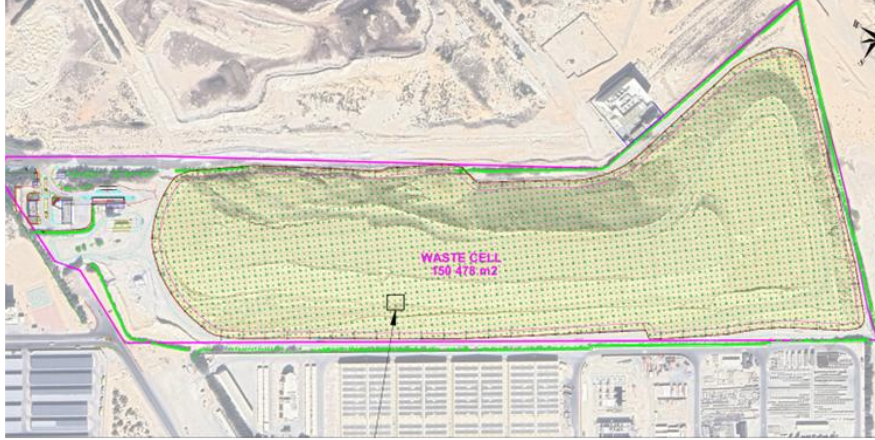

AES in association with Suereca provided design services to Dubai Municipality (DM) for closures and re-shaping of 6-dump sites in Dubai and Jebel Ali including surface treatment, gas extraction system, solar farms feasibility, capping options, green fields development, slope stability assessment, drainage design and cost estimates.

Design and Engineering Services for Waste
Dump Sites Closures & Development of
Environmental Solutions. Abu Dhabi, UAE

AES with Suereca provided engineering and consultancy services related for TADWEER project in Abu Dhabi for closures of 9-dump sites including groundwater treatment options, surface treatment, gas extraction system, capping options, green fields development, slope stability assessment, drainage design, plans & profiles, electric power and cost estimates.

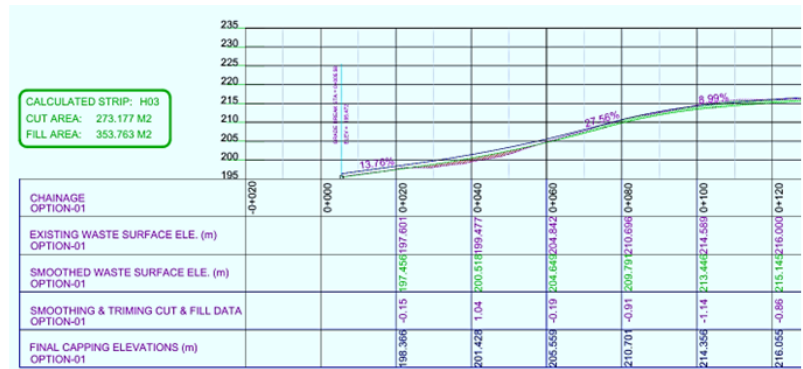

Brine Water Treatment

Detailed Design of Dammam Correctional Facilities Reject
Water System Handling and Pond. Dammam, Saudi Arabia

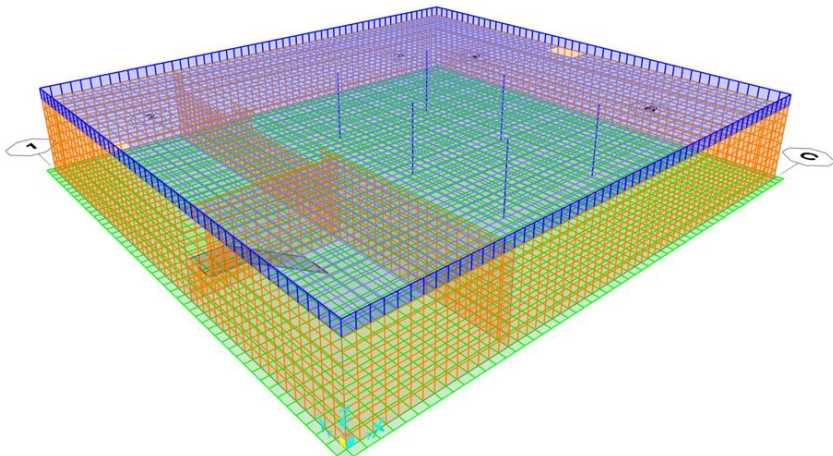

Detailed design of the Reject Water System containing high TDS from RO plant outfall including tanks, pumps, transport pipelines, and ZLD (Zero Liquid Discharge) evaporation pond to ensure no liquid accumulation and no impact to groundwater or surrounding environments.





Treatment Technology Engineering

Engineering Consultancy for Acidic Wastewater Treatment Technology (PCR)

AES is partnered with Arabian for Science and Technology Co. (ASTC) as the engineering consultant for preparation of design and engineering documents and providing consultancy services for implementation of new acquired technology for treatment of Acidic Wastewater in SABIC and other industries in the Kingdom of Saudi Arabia.

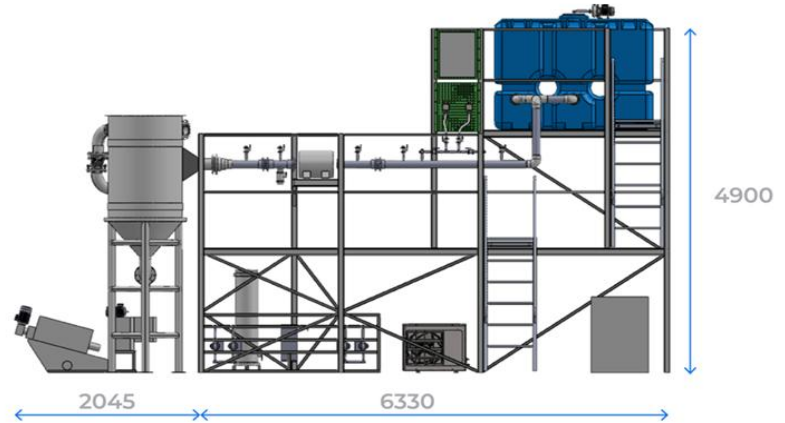

Sewage Treatment Plants

QGWP - Detailed Design of Piping & Chemical Skids Design, Qatar Gas

AES is contracted by VEOLIA Middle East for detailed design of piping system, stress analysis, structural modelling and calculations and preparation of fabrication drawings including isometrics, equipment skids details, pipe supports, foundations and platforms design.

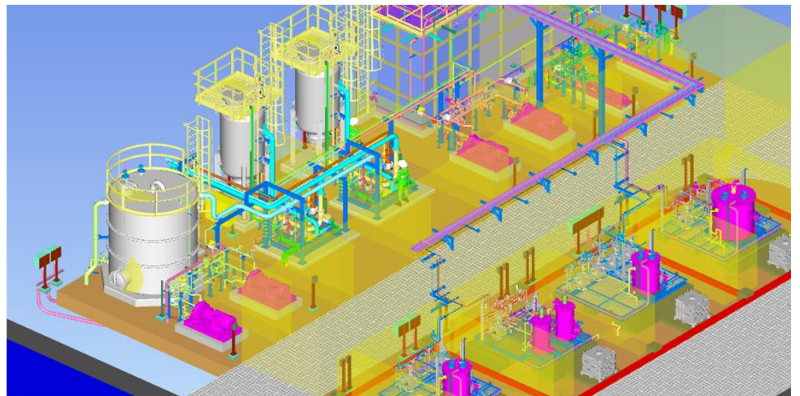

Key Clients



Marine & Urban Developments (2015-2025)

Project No.	Title	Client	Scope	Year
1	Engineering Review & Technical Support - Marine & Civil Works for Jetties 2,3 and 4 Khor Zubair Port. <i>Basra, Republic of Iraq</i>	Consulting Bureau – Iraqi Engineers Union	Review of technical and commercial proposal for Khor Zubair Port Rehabilitation, project work included preparation of technical specifications for basin dredging, cathodic protection, jetties upgrades and civil works.	2025
2	Uqair Area Development Company (UADC), Phase-1 Land Preparations & Marine Works Development. <i>Al-Uqair, Saudi Arabia</i>	PIF / UADC Sub-Consultant	Design and preparation of tender package for land preparation and marine works including topography, geotechnical, marine structures and marina basin, hydrology review, logistics requirements and project master schedule.	2024
3	Concept Master Plan for Proposed Muzahmiya Entertainment Complex. <i>Riyadh, Saudi Arabia</i>	Private Investment Group	Preparation of concept master plan, zoning and phasing plan for a proposed development as commercial and entertainment hub in Muzahmiyah, near Riyadh City. The project involved several innovative space design.	2023
4	Al-Attas Land Marine Works Preparation of Design & Contract Documents. <i>Khobar, Saudi Arabia</i>	Saudi Tharwa	Preparation of reclamation and shore protection design for 2,000,000 m2 land development near Tharwa Town, Khobar.	2022
5	Marasi Al-Khobar Marine Works Preparation of Design & Contract Documents. <i>Dammam, Saudi Arabia</i>	RETAL	Preparation of reclamation and shore protection design for 1,800,000 m2 land development near Dammam Port.	2022
6	Concept Master Plan for Island-A - Saudi Side <i>Eastern Province, Saudi Arabia</i>	King Fahd Causeway Authority (KFCA)	Preparation of concept master plan for development of the Saudi-Side New Island as commercial and entertainment hub.	2022



Marine & Urban Developments (2015-2025)

Project No.	Title	Client	Scope	Year
7	North Hills Master Plan, Architectural & Land Development Design. <i>El-Koura, Lebanon</i>	North Hills Real-Estate	Master plan, architectural & development design for prestigious residential resort & holiday homes development.	2021
8	Cornish Al-Khobar Marine Works Preparation of Design & Contract Documents. <i>Dammam, Saudi Arabia</i>	Saudi Tharwa	Preparation of reclamation and shore protection design for 3,500,000 m2 land development (Cornish Al-Khobar).	2021
9	KFCA Island Remaster Plan Local Engineering Technical Support. <i>Eastern Province, Saudi Arabia</i>	Intecsa-Inarsa / KFCA (King Fahd Causeway Authority)	Providing architectural and master planning local engineering support to Intecsa-Inarsa for the KFCA Island Remaster Plan (Marine & Infrastructures).	2021
10	Tender Documents for Land Development and Infrastructures - Obhur Land - Plots 9A and 9B. <i>Jeddah, Saudi Arabia</i>	Saudi Tharwa	Preparation of tender documents and specifications for development infrastructure - Obhur Plots 9A and 9B.	2020
11	Nahkeel - Tharwa Town Cornish Road Segment Design of Reclamation & Marine Works. <i>Dammam, Saudi Arabia</i>	Saudi Tharwa	Reclamation, shore protection and road infrastructure design for Cornish road connection of Nahkeel – Tharwa Town.	2020
12	Tharwa Town Development Marine Works Preparation of Design & Contract Documents. <i>Dammam, Saudi Arabia</i>	Saudi Tharwa	Preparation of reclamation and shore protection design for 4,400,000 m2 land development (Tharwa Town).	2017
13	Technical & Consultancy Support for Construction of New Island Reclamation. <i>Eastern Province, Saudi Arabia</i>	TYLOS - NCS / KFCA (King Fahd Causeway Authority)	Technical support to KFCA during master plan development and construction of marine works of New Island (Saudi Side).	2015



Architectural & Buildings Projects Experience (2016-2025)

Project No.	Title	Client	Scope	Year
1	Rose Villas Compound – Bid Stage Design & Development of BOQs. <i>Dammam, Saudi Arabia</i>	Al-Yamama Group Co.	Preparation of structural design for all villas types and BOQs for all works including Architectural, Structural and MEP systems.	2025
2	Homs City Vocational Training Center - Detailed Design. <i>Homs, Syria</i>	Homs Municipality	Preparation of detailed design for a new education facility in Homs City, Syria (1,200 Tenants) including buildings, MEP and infrastructures facilities.	2025
3	Detailed Engineering & Design Services - IET Expansion Project. <i>Dammam, Saudi Arabia</i>	Baker Hughes / WestCon	Preparation of detailed design for buildings, MEP and infrastructures facilities for expansion of Baker Hughes Oil& Gas manufacturing supporting IET facilities in Dammam 2 nd Industrial City including Master Plan, Shop Areas, Logistics Areas, Offices, Equipment Supporting Systems, Utilities and local authority's submissions.	2024-2025
4	Detailed Engineering & Design Services - SPARK ALS Progressive Facilities. <i>SPARK, Saudi Arabia</i>	Baker Hughes / WestCon	Preparation of detailed design for main ALS building and associated MEP infrastructures for added facilities at Baker Hughes SPARK Plant for Oil& Gas support including Main Shop, Offices and Equipment MEP Systems.	2024
5	Makkah Courts Complex Buildings, Cost Engineering Support. <i>Makkah, Saudi Arabia</i>	Intecsa-Inarsa Sa.	Preparation of BOQs, design and materials specifications for a major building complex in Makkah with extensive MEP systems. Project included review and development of architectural finishing drawings, Fire & Life Safety plans in addition to structural and earthworks materials take-offs.	2023



Architectural & Buildings Projects Experience (2016-2025)

Project No.	Title	Client	Scope	Year
6	STC Exchange Buildings Modelling & Structural Assessment. <i>Saudi Arabia</i>	Saudi Telecom Company (STC)	Buildings modelling and structural assessment for several STC Exchanges (40-buildings) in Eastern, Central and Western regions of Saudi Arabia. Engineering consultancy services including concrete repairs and structural strengthening design and supervision.	2022-2024
7	OXAGON Terminal Main Warehouse Structural Modelling & Design. <i>NEOM, Saudi Arabia</i>	ESEC / Intecsa-Inarsa Sa.	Preparation of structural modelling for technical design proposal of OXAGON Terminal, speciality building (L=500m, W=450m, H=85m). In addition to building MEP systems preliminary design and BOQs preparations.	2023
8	CEER Manufacturing Facilities Steel Structures Alternative Design. <i>Saudi Arabia</i>	ESEC / Intecsa-Inarsa Sa.	Preparation of buildings design and technical solutions for tender stage support including Production, Assembly Shops, Painting Shops, Battery Shops and other buildings.	2023
9	OLAYAN Al-Bustan Business Park Buildings Structural Design. <i>Riyadh, Saudi Arabia</i>	AYESA - Spain / Basic Engineering Co.	Al-Bustan Business Park, design of prestigious multi-purpose buildings with total built-up area over 55,000 m2 including offices, HQ & multi-story parking.	2023
10	Riyadh Stone House Private Resort. <i>Riyadh, Saudi Arabia</i>	AZAZ Architects / Private Development	Design of luxury private resort residence and facilities with guest villas, pavilions and other facilities. Resort re-treat near Riyadh with Wadi views.	2023



Architectural & Buildings Projects Experience (2016-2025)

Project No.	Title	Client	Scope	Year
11	Al-Ula Visitors Center Building – Structural Design. <i>Al-Ula, Saudi Arabia</i>	AZAZ Architects / Al-Ula Authority	Structural Design of specialty visitors center building in Al-Ula.	2023
12	Master Planning & Architectural Theme Proposal Concept for King Salman Reservation in Tubaiq – Headquarter Facilities. <i>Riyadh, Saudi Arabia</i>	PROF Consult / King Salman Bin Abdulaziz Royal Reserve	Preparation of master plan and architectural design concept for a prestigious project including HQ building and facilities required for King Salman Reservation in Tubaiq.	2021
13	North Hills Residence-I Building Design & Construction Supervision. <i>El-Koura, Lebanon</i>	North Hills	Preparation of detailed design including architectural, structural & MEP and construction supervision.	2021
14	Private Villas, Architectural Themes & Detailed Design Development. <i>Kuwait City, Kuwait</i>	Private Clients	Preparation of architectural design concept and detailed design including architectural, structural & MEP systems.	2021
15	Mountain Residential Building Modernization and Rehabilitation. <i>Hammama, Mount Lebanon</i>	Private Clients	Color schemes, cladding design, structural and finishings repairs and MEP systems rehabilitation.	2021
16	Two Story & Three Story, Bedrooms Dormitory. <i>Bacolod City, Philippines</i>	Basic Chemicals Industries (BCI)	Preparation of concept and detailed design including architectural, structural & MEP systems.	2020
17	Pavia Deca Homes Additions (Expansion of Existing Residential Homes). <i>Iloilo City, Philippines</i>	Pavia Deca Development	Preparation of detailed design including architectural, structural & MEP systems.	2019



Architectural & Buildings Projects Experience (2016-2025)

Project No.	Title	Client	Scope	Year
18	Buildings Codes & Fire Exists Review & Drawings, Hydrochloric Acid Synthesis Plant. <i>Jubail, Saudi Arabia</i>	Basic Chemicals Industries (BCI)	Review of buildings architectural design for egress routes, fire exists, corridors ...etc... and modify design drawings accordingly.	2019
19	Hydrochloric Acid Synthesis Plant - Interior Design & Color Schemes -Selected Buildings. <i>Jubail, Saudi Arabia</i>	Basic Chemicals Industries (BCI)	Architectural finishing, colors and themes selection for the main plant's buildings. Exterior and interior 3D rendering and views.	2018
20	Design of Piping Fabrication Shop. <i>Dammam, Saudi Arabia</i>	General Consolidated Contractors Ltd. (GCC)	Preparation of detailed design including architectural, structural & MEP for industrial workshop building.	2017
21	Design of New Plant Extension - Dammam 2nd Industrial City. <i>Dammam, Saudi Arabia</i>	Saudi Pallets Manufacturing Company (PAXXAL)	Preparation of detailed design including architectural, structural & MEP for PAXXAL new plant expansion.	2017
22	Fire Protection Design Review – NFPA Compliance for Khafji Joint Operation (KJO). <i>Al-Khaffji, Eastern Province, Saudi Arabia</i>	Saud Consult / Khafji Joint Operation (KJO)	Design review and NFPA compliance certification for facilities and buildings upgraded by KJO.	2016



Infrastructures Projects Experience (2016-2025)

Project No.	Title	Client	Scope	Year
1	Hydrology Flood Assessment - Jizan District STC Sabya Exchange Building. <i>Jizan, Saudi Arabia</i>	Saudi Telecom Company (STC)	Hydrology modelling and design of flood control measures for protection of STC Exchange Building at Sabya – Jizan District	2025
2	Rua Al-Madina - Structural Design for Flagpole and Landscape Pump Rooms. <i>Medinah, Saudi Arabia</i>	Rua Al-Madina Holding / ICON	Structural design of monumental Flagpole with 80 m height including study of effects on underground tunnels. Project included structural design of pumping rooms and other facilities required for the Rua A-Madinah landscape package.	2025
3	The Avenues Riyadh External Roads - Underpasses 5,6 & 7 Shop Drawings. <i>Riyadh, Saudi Arabia</i>	The Avenues / Al Omaier	Preparation of detailed shop drawings for complex main highways underpasses intersection required for the Avenues project in Riyadh City.	2024
4	Jubail Royal Commission Villas Residential Project - Infrastructures Utilities Package. <i>Jubail, Saudi Arabia</i>	Abyatona / Intecsa	Preparation of detailed design for development of 1000 residential villas project in Royal Commission including wet utilities, power supply and telecom network.	2024
5	Design of NEOM Railway Depot Connector Tracks Works and Slabs <i>NEOM, Saudi Arabia</i>	MARTINUS / Intecsa	Design of 55 km main depot tracks including tracks slabs, elevated tracks pedestals, turnouts, earthing & bonding. Design included structural modelling and design of joints, layouts of electrical power posts. Project work included quantification of civil/structural, electrical and signaling works.	2023



Infrastructures Projects Experience (2016-2025)

Project No.	Title	Client	Scope	Year
6	Design of Landscapes & Irrigation Systems Saudi Arabia Land Borders Customs Areas <i>Land Borders, Saudi Arabia</i>	Saudi Customs Borders / PROF Consult	Design of landscape and irrigation systems including 3D rendering for several Saudi Arabia Land Borders Customs areas including Halat Ammar, Al-Batha, Salwa and Al-khafji.	2022
7	Traffic Study & Modelling at ITHRA Building <i>Dhahran, Saudi Arabia</i>	Gulf Consolidated Contractors (GCC) / Saudi Aramco	Traffic study for and preparation of real-time movement using PTV-VISSIM modelling for the main highways junction at ITHRA building for Impact during construction works related to landscape and irrigation at ITHRA Building.	2022
8	NEOM Gayal & Spine Water Pipelines Bid Stage Engineering Support <i>NEOM, Saudi Arabia</i>	Al-Yamama Contracting	Preparation of BOQs, preliminary design and technical proposal assistance activities to facilitate bid submissions of two(2) NEOM water transmission pipelines projects.	2022
9	KAFD Solid Waste Transfer Pipeline <i>Riyadh, Saudi Arabia</i>	King Abdullah Financial District / Basic Engineering Co.	Design of solid waste transfer system including ducts, supports and suction system for King Abdullah Financial District (KAFD).	2022
10	THAAD Sites Bid Stage Engineering Support <i>Ministry of Defense, Saudi Arabia</i>	Al-Yamama Contracting	Preparation of BOQs and preliminary design to facilitate bid submission for THAAD project.	2022
11	KHZM Pipeline Deep Excavation Stability Modelling & Design, Saudi Aramco. <i>Saudi Arabia</i>	Gulf Consolidated Contractors (GCC) / Saudi Aramco	Modelling and design of slope stability for deep excavation of major KHZM Gas Pipeline (120 km) for Saudi Aramco project in the southern area. Work involved modelling using Slope/W and stability design solutions.	2022



Infrastructures Projects Experience (2016-2025)

Project No.	Title	Client	Scope	Year
12	Traffic Modelling for Border Island Expansion, King Fahd Causeway Authority Remaster Plan. <i>Saudi Arabia / Kingdom of Bahrain</i>	Intecsa-Inarsa / King Fahd Causeway Authority	Preparation of complete real-time traffic movement using PTV-VISSIM modelling for the new expansion project 4000 Veh./Hr.	2021
13	Design of Service Roads for CTW120 Railway <i>Dammam, Saudi Arabia</i>	Saudi Railway (SAR) / Al Omaier	Detailed design of railway service roads required for Dammam – Jubail Railway line.	2021
14	Design of Remedial Works for Qurayyat - Al-Jouf Railway Line. <i>Al-Jouf, Saudi Arabia</i>	Saudi Railway (SAR) / Al Omaier	Detailed design of railway structures including bridge, culverts, hydrology structures, railway tracks and miscellaneous remedial works for Al-Jouf – Qurayyat line.	2021
15	Preliminary Design & BOQ Development for NSR Remedial Works Tender. <i>Ras Al-Khair, Saudi Arabia</i>	Saudi Railway (SAR) / Al Omaier	Preliminary design and quantities estimates of railway structures for bid stage support, NSR railway line.	2021
16	ETAP Modelling for Step & Touch Potential Main Substations Grounding – New HAS Plant. <i>Jubail, Saudi Arabia</i>	Basic Chemicals Industries (BCI)	Carrying out Electrical Transient Analysis for the step and touch potential to verify the design of the main substations grounding.	2020
17	DIALUX Lighting Levels Modelling for HCIS Requirements – New HAS Plant. <i>Jubail, Saudi Arabia</i>	Basic Chemicals Industries (BCI)	DIALUX modelling for exterior and interior lighting at the main gate house and security fence to comply with HCIS requirements.	2020
18	Nahkeel - Tharwa Town Cornish Road Design – Geometry & Infrastructures. <i>Dammam, Saudi Arabia</i>	Saudi Tharwa	Coastal road & infrastructure design for cornish connection between Nahkeel and Tharwa Town. Alignment, sections & details.	2020
19	Design of Railway Bridge Crossings – Jubail Industrial City. <i>Jubail, Saudi Arabia</i>	TRICORP / SAUD CONSULT Royal Commission	Detailed design of railway bridge crossing - Jubail Industrial City.	2019



Infrastructures Projects Experience (2016-2025)

Project No.	Title	Client	Scope	Year
20	Re-design of Culvert-1 for Royal Commission Railway Crossings. <i>Ras Al-Khair, Eastern Province, Saudi Arabia</i>	SAR / Al Omaier	Modifications of detailed design of railway box culverts crossing – Ras Al-Khair.	2019
21	Preparation of Railway Sand Mitigation Design, CTW 120, Jubail – Dammam Junction. <i>Dammam, Saudi Arabia</i>	SAR / Al Omaier	Preparation of Sand Mitigation design for CTW Railway Project (108 Km) between JIC and Dammam. Sand flux & risk evaluations.	2018
22	Railway Crossings & Pipe Bridges of Eastern Utility Corridor – Design Shop Drawings. <i>Ras Al-Khair, Eastern Province, Saudi Arabia</i>	SAR / Al Omaier	Design verification and preparation of detailed shop drawings for railway ballasts, embankments, bridges & culverts crossings.	2017
23	KIMS Care Hospital Traffic Impact Assessment Report – Um Al-Hassam. <i>Kingdom of Bahrain</i>	TYLOS - NCS / KIMS Care	Preparation of Traffic Impact Assessment for new hospital in Bahrain. Mapping, field traffic counts and PTV VISSIM modelling.	2016



Oil & Gas and Industrial Projects Experience (2015-2025)

Project No.	Title	Client	Scope	Year
1	Detailed Engineering & Design Services for SeAH Project. <i>SPARK, Saudi Arabia</i>	Western Contractors / SeAH Investment	Detailed design for new specialty steel manufacturing plant in SPARK Industrial City including CFD modelling, buildings, facilities, infrastructures, MEP systems, landscape, E&I systems and civil/structural works. Preparation of detailed design and shop drawings and construction details.	2025
2	Detailed Engineering & Design Services for SPC Expansion Project. <i>Dammam, Saudi Arabia</i>	Baker Hughes	Specialized systems design including test bays, workshops and CNC machines installations system for Baker Hughes SPC Expansion Project including architectural, structural, infrastructures & MEP systems	2025
3	Fadhli WWTP Logic Diagrams Design, Saudi Aramco. <i>Fadhli Facilities, Saudi Arabia</i>	Veolia Water Technologies / Saudi Aramco	Instrumentation and control design for WWTP at Fadhli Gas Plant, review and amendments of systems and P&IDs and preparation of logic diagrams and supporting engineering documents.	2025
4	Engineering & Detailed Design - IET Expansion Project (Phase-I & Phase-II). <i>Dammam, Saudi Arabia</i>	Baker Hughes	Master plan development for Baker Hughes IET Expansion Project and commencement of detailed design for several buildings and facilities including architectural, structural, infrastructures & MEP systems.	2024



Oil & Gas and Industrial Projects Experience (2015-2025)

Project No.	Title	Client	Scope	Year
5	Jafurah Sewage Treatment Plant Detailed Design & CMMS Technical Support. <i>Jafurah, Saudi Arabia</i>	SinoHydro / Saudi Aramco	Detailed design of new STP plant for Saudi Aramco including piping/mechanical, electrical, instrumentation & control, infrastructures, process utilities, structural design and 3D modelling.	2023 - 2024
6	Zuluf Saline Water Treatment Plant Preliminary Design & PPP Technical Support – Oil field Water Injection (800,000 BPD). <i>Tanajib, Saudi Arabia</i>	Al-Yamama Group Co. / Association with Veolia	Prepare process & plant facilities design including saline water process packages, piping and facilities for technical proposal and financial cost estimates required for Saudi Aramco PPP tender.	2022
7	Saudi Pallets Manufacturing Company (SPMC) / PAXXAL Inc. Plant Expansion Design & Construction Supervision. <i>Dammam, Saudi Arabia</i>	Saudi Pallets Manufacturing Company (SPMC)	Detailed design for Roto-Molding technology plastic pallets manufacturing plant in Dammam 2nd Industrial City including process equipment setting, cooling system design, E&I systems and civil/structural works. Preparation of tender documents, shop drawings and construction supervision. Stress Modelling of product pallets under racking and packaging loading cases.	2022
8	Engineering Support For Saudi Aramco Pipelines Design @ KHZ3. <i>Haradh, Saudi Arabia</i>	General Consolidated Contractors Ltd. (GCC) / Saudi Aramco	Engineering support for design and construction of new Saudi Aramco pipelines @ KHZ3.	2021
9	Offshore Seawater Intake & Cooling System with Overflow Piping for New Hydrochloric Acid Synthesis Plant. <i>Jubail, Saudi Arabia</i>	Basic Chemicals Industries (BCI)	Hydraulics, piping/mechanical and structural design of offshore and on-shore facilities of Seawater Cooling System of the new Hydrochloric Acid Synthesis Plant.	2020



Oil & Gas and Industrial Projects Experience (2015-2025)

Project No.	Title	Client	Scope	Year
10	Hydrochloric Acid Synthesis Plant, Bertram, PA-07 (U-LUM) Process Buildings, Stacks and B-25 (Veolia Building). <i>Jubail, Saudi Arabia</i>	Basic Chemicals Industries (BCI)	Preparation of detailed engineering including process requirements review, structural, mechanical and electrical design for three (3) process buildings including stacks and associated LPS protection.	2020
11	Design of Lube Oil Plant. <i>Dammam, Saudi Arabia</i>	General Consolidated Contractors Ltd. (GCC) / Saudi Aramco	Preparation of detailed design including process requirements, structural & MEP for lube oil processing building.	2020
12	Analysis and Design of Radiation Shield UTFG-6 & UTKHCL-3 Burn Pit - Saudi Aramco Pipelines. <i>Khobar, Saudi Arabia</i>	General Consolidated Contractors Ltd. (GCC) / Saudi Aramco	Preparation of process calculations for estimation of heat flux on nearby equipment to pipelines burn pits and design of suitable radiation shield walls.	2018
13	Hydraulic Modeling (PIPENET & PIPE-FLO) - Fire Protection Systems - Saudi Aramco Camps. <i>Eastern Province, Saudi Arabia</i>	CAT, CPP & GCC Saudi Aramco Contractors	Preparation of detailed design for several Saudi Aramco temporary facilities camps including architectural, structural & MEP systems with hydraulic cross-loop modelling of firewater networks.	2015 - 2016
14	Pipe Stress Analysis (CAESAR-II) - Dynamic & Vibration Modal Analysis – Pipelines Projects. <i>Khobar, Saudi Arabia</i>	General Consolidated Contractors Ltd. (GCC)/CAT & Others)	Perform Pipe Stress Analysis by (CAESAR-II) for several pipelines and process equipment installations for various plants and pipelines project. 3D Modelling of piping and equipment arrangements.	2015 - 2022



Environmental & Sustainability Projects Experience (2019-2025)

Project No.	Title	Client	Scope	Year
1	Engineering Services for Dubai Municipality Dump Sites Re-shaping, Closures & Environmental Solutions. <i>Dubai, United Arab Emirates</i>	DM – Dubai United Arab Emirates	AES in association with Suereca provided engineering support and conceptual design to Dubai Municipality (DM) for re-shaping, closures and environmental solutions development for 6-dump sites in Dubai and Jebel Ali including surface treatment, gas extraction system, solar farms feasibility, capping options, green fields development, slope stability assessment, drainage design, plans & profiles, electric power and cost estimates.	2025
3	Detailed Design of Dammam Correctional Facilities Reject Water System Handling and Evaporation Pond. <i>Dammam, Saudi Arabia</i>	Saudi Bin Laden Group/ Ministry of Interior	Detailed design of the Reject Water System containing high TDS from RO plant outfall including tanks, pumps, transport pipelines, and ZLD (Zero Liquid Discharge) evaporation pond to ensure no liquid accumulation and no impact to groundwater or surrounding environments.	2025
2	Design and Engineering Services for Waste Dump Sites Closures & Development of Environmental Solutions. <i>Abu Dhabi, United Arab Emirates</i>	TADWEER – Abu Dhabi United Arab Emirates	AES is hired by Suereca to provide engineering and consultancy services related for TADWEER project in Abu Dhabi for closures of 9-dump sites including groundwater treatment options, surface treatment, gas extraction system, capping options, green fields development, slope stability assessment, drainage design, plans & profiles, electric power and cost estimates.	2024



Environmental & Sustainability Projects Experience (2019-2025)

Project No.	Title	Client	Scope	Year
4	Design and Engineering Services for PETROKEMYA Air Sparging System for Ground Water Treatment & Subsurface Redemption Program. <i>Jubail, Saudi Arabia</i>	SABIC – PETROKEMYA / ARM Associates	AES is partnered with ARM Associates (leading environmental consultant in the GCC region) to carry out the conceptual and detailed design for the Air Sparging System required by PETROKEMYA for treatment of ground water and redemption of contaminated subsurface soil layers by accumulation of industrial wastes including hydrocarbon and other chemicals. The project involved process design of the air sparging wells, process decomposition monitoring, compressed air, electric power and utilities systems.	2023
5	OLAYAN Al-Bustan Business Park Buildings Structural Design. <i>Riyadh, Saudi Arabia</i>	AYESA - Spain / Basic Engineering Co.	Al-Bustan Business Park, design of prestigious multi-purpose buildings with total built-up area over 55,000 m ² including offices, HQ & multi-story parking with innovative systems, materials and green solutions.	2023
6	Riyadh Stone House Private Resort. <i>Riyadh, Saudi Arabia</i>	AZAZ Architects / Private Development	Design of luxury private residence with natural stones, and environmental solutions for pavilions and other facilities. Resort re-treat near Riyadh with Wadi views.	2023
7	Al-Ula Visitors Center Building – Structural Design. <i>Al-Ula, Saudi Arabia</i>	AZAZ Architects / Al-Ula Authority	Design of visitors center building in Al-Ula with special design features and materials with the aim to obtain LEED Gold rating.	2023
8	Detailed Engineering - Jafurah Gas Plant Sewage Treatment Plant - Saudi Aramco <i>Jafurah, Saudi Arabia</i>	Saudi Aramco / SinoHydro & Veolia	Prepare detailed design for complete new STP which is part of the new Jafurah Gas Plant. AES contracted by both SinoHydro and Veolia to complete the whole plant design including 3D modelling, equipment layouts, utilities, instrumentation and control, piping design, civil/structural, ponds, drying beds, roads and site utilities.	2023



Environmental & Sustainability Projects Experience (2019-2025)

Project No.	Title	Client	Scope	Year
9	Detailed Engineering - Zuluf CPF (Central Processing Facilities) Sewage Treatment Plant - Saudi Aramco <i>Zuluf, Saudi Arabia</i>	Saudi Aramco / KIC & Veolia	Prepare detailed design for complete new STP which is part of Zuluf CPF Plant. AES contracted by both KIC and Veolia to complete the whole plant design including with feed water to plant's irrigation system. Work included 3D modelling, equipment layouts, utilities, instrumentation and control, piping design, civil/structural, ponds, drying beds, roads and site utilities. Work included electrical main power supply (MCC Building) and Control Room. Scope included fabrication and shop drawings for structural steel, piping and irrigation system elements.	2022
10	Engineering Consultancy Services for the OSCAR Project - Industrial Hazardous Waste and General Waste Plant. <i>Dhahran, Saudi Arabia</i>	Saudi Aramco – Veolia Joint Venture	AES is hired by Suereca to provide engineering and consultancy services related to the plant's facilities and infrastructures. project is a JV between Saudi Aramco and Veolia. Preparation of master plan, RFP package and FEED design for major Industrial Hazardous Waste (IHW) and General Waste (GSW) Plant in Dhahran, Saudi Arabia.	2022
11	Zuluf Saline Water Treatment Plant Preliminary Design & PPP Technical Support – Oil field Water Injection (800,000 BPD). <i>Tanajib, Saudi Arabia</i>	Saudi Aramco / Al-Yamama Group Co. Association with Deloitte & Veolia	AES is hired as the Technical Advisor to prepare process & plant facilities design layouts, sizing and integration of various process packages including saline water process package, gas incineration package, solid wastes treatments package ...etc... Design included sizing of main equipment, piping, facilities, utilitiesetc... Project included preparing technical proposal and cost estimates required for Saudi Aramco PPP tender.	2021



Environmental & Sustainability Projects Experience (2019-2025)

Project No.	Title	Client	Scope	Year
12	Engineering Feasibility Study for Hills Sanitary Landfill & Water Treatment Requirements. <i>Koura, Lebanon</i>	Holcim / Koura Municipalities	Preliminary technical and financial feasibility study for transforming the cut hills into sanitary landfill with environmental controls, collection and treatment options of the drainage water and possible installation and utilization of gas collection system. Project also addressed garbage collection and recycling schemes in the region.	2021
13	Expand Wastewater Treatment Plant, Abqaiq Residential Camp. <i>Abqaiq, Saudi Arabia</i>	Saudi Aramco / Gulf Contracting Co. (GCC)	Prepare design for specific facilities and utilities required for expanding existing wastewater treatment plant in Abqaiq (Saudi Aramco Facilities).	2019





Registrations & Certificates





CERTIFICATE CONFIRMING INCORPORATION OF COMPANY

Company Name : **ADVANCED ENGINEERING SOLUTIONS (SG) PTE. LTD.**

UEN : **202211632W**

This is to confirm that the company was incorporated under the Companies Act, on and from **05/04/2022** and that the company is a **EXEMPT PRIVATE COMPANY LIMITED BY SHARES**.



TAN YONG TAT
ASST REGISTRAR OF COMPANIES & BUSINESS NAMES
ACCOUNTING AND CORPORATE REGULATORY AUTHORITY
SINGAPORE

Dated : **05/04/2022**
Receipt Number : **ACRA220405134050**



Authentication No. : T22259961T

Whilst every endeavor is made to ensure that information provided is updated and correct, ACRA disclaims any liability for any damage or loss that may be caused as a result of any error of omission.

Business Profile (Company) of **ADVANCED ENGINEERING SOLUTIONS (SG) PTE. LTD. (202211632W)**

Date: 08 Dec 2025

Name of Company	:	ADVANCED ENGINEERING SOLUTIONS (SG) PTE. LTD.
Former Name if any	:	
Date of Change of Name	:	
UEN	:	202211632W
Incorporation Date	:	05 APR 2022
Company Type	:	EXEMPT PRIVATE COMPANY LIMITED BY SHARES
Status of Company	:	LIVE COMPANY
Status Date	:	05 APR 2022
Registered Office Address	:	1 RAFFLES PLACE, #20-02, ONE RAFFLES PLACE, SINGAPORE 048616
Date of Address	:	05 SEP 2025
Date of Last AGM	:	30 SEP 2024
Date of Last AR	:	30 DEC 2024
FYE As At Date of Last AR	:	31 MAR 2024

Business Activities

Primary Activity	:	GENERAL BUILDING ENGINEERING DESIGN AND CONSULTANCY SERVICES (71121)
Secondary Activity	:	

Verify Document Instantly

Check if this document is issued by ACRA.

<https://www.acratrustbar.gov.sg/verify/RBWUJxEmTD>



Whilst every endeavor is made to ensure that information provided is updated and correct, ACRA disclaims any liability for any damage or loss that may be caused as a result of any error of omission.

Business Profile (Company) of ADVANCED ENGINEERING SOLUTIONS (SG) PTE. LTD. (202211632W)

Date: 08 Dec 2025

Issued Share Capital

Amount	Number of Shares ¹	Currency	Share Type
100	100		ORDINARY

¹ Number of Shares includes number of Treasury Shares

Paid-Up Capital

Amount	Number of Shares	Currency	Share Type
100	100		ORDINARY

Company has the following Ordinary Shares held as Treasury Shares

Number of Shares	Currency
------------------	----------

Audit Firm(s)

Name

Charge(s)

Charge Number	Date Registered	Currency	Amount Secured	Chargee(s)
---------------	-----------------	----------	----------------	------------

Verify Document Instantly

Check if this document is issued by ACRA.

<https://www.acratrustbar.gov.sg/verify/RBWUJxEmTD>



Whilst every endeavor is made to ensure that information provided is updated and correct, ACRA disclaims any liability for any damage or loss that may be caused as a result of any error of omission.

Business Profile (Company) of **ADVANCED ENGINEERING SOLUTIONS (SG) PTE. LTD. (202211632W)**

Date: 08 Dec 2025

Officer(s)				
Name	Identification Number	Nationality/ Citizenship	Position	Date of Appointment
Address AU FEI LING 1 RAFFLES PLACE, #20-02, ONE RAFFLES PLACE, SINGAPORE 048616	S7471663F	SINGAPORE CITIZEN	DIRECTOR	08 DEC 2025
HONG XUELING 1 RAFFLES PLACE, #20-02, ONE RAFFLES PLACE, SINGAPORE 048616	S8139204H	SINGAPORE CITIZEN	SECRETARY	05 SEP 2025
GHADAH KASSAB FLAT 45 BLD 2424 ROAD 5718 AMWAJ KINGDOM OF BAHRAIN	AR455848	CANADIAN	DIRECTOR	05 APR 2022
TAN BEE HUAY (CHEN MEIHUA) 1 RAFFLES PLACE, #20-02, ONE RAFFLES PLACE, SINGAPORE 048616	S7230069F	SINGAPORE CITIZEN	SECRETARY	05 APR 2022

Verify Document Instantly

Check if this document is issued by ACRA.

<https://www.acratrustbar.gov.sg/verify/RBWUJxEmTD>



Whilst every endeavor is made to ensure that information provided is updated and correct, ACRA disclaims any liability for any damage or loss that may be caused as a result of any error of omission.

Business Profile (Company) of **ADVANCED ENGINEERING SOLUTIONS (SG) PTE. LTD. (202211632W)**

Date: 08 Dec 2025

Shareholder(s)

Name	Identification Number	Nationality ² / Place of origin ³	Number of Shares	Address Changed
GHADAH KASSAB	AR455848	CANADIAN	100 (ORDINARY)	
FLAT 45 BLD 2424 ROAD 5718 AMWAJ KINGDOM OF BAHRAIN				

² Includes nationality and citizenship

³ Includes place of incorporation, place of origin and place of registration

Abbreviation

UL	:	Local Entity not registered with ACRA
UF	:	Foreign Entity not registered with ACRA
AR	:	Annual Return
AGM	:	Annual General Meeting
FS	:	Financial Statements
FYE	:	Financial Year End

Verify Document Instantly

Check if this document is issued by ACRA.

<https://www.acratrustbar.gov.sg/verify/RBWUJxEmTD>



Whilst every endeavor is made to ensure that information provided is updated and correct, ACRA disclaims any liability for any damage or loss that may be caused as a result of any error of omission.

Business Profile (Company) of **ADVANCED ENGINEERING SOLUTIONS (SG) PTE. LTD. (202211632W)**

Date: 08 Dec 2025

Notes

- 1 All the information provided above are extracted from lodgements filed with ACRA and/or from other government sources.
- 2 Please check to ensure that this document is issued by ACRA by:
 - (a) scanning the verification QR code at the bottom of the page, or
 - (b) visiting the verification URL at the bottom of the page, or
 - (c) uploading the verifiable OpenAttestation file (e.g. Business_Profile.0a) on www.acratrustbar.gov.sg.



TAN YONG TAT

ASST REGISTRAR OF COMPANIES & BUSINESS NAMES
ACCOUNTING AND CORPORATE REGULATORY AUTHORITY (ACRA)
SINGAPORE

RECEIPT NO. : ACRA251208001857

DATE : 08 DEC 2025

Verify Document Instantly

Check if this document is issued by ACRA.

<https://www.acratrustbar.gov.sg/verify/RBWUJxEmTD>



BUSINESS LICENSE رخصة تجارية

License No.	4416116.01	رخصة تجارية
Company Name Advanced Engineering Solutions Consultancy FZC		اسم الشركة أدفانسد لاستشارات الحلول الهندسية ش م ح
Formation Type Free zone company		نوع التأسيس شركة منطقة حرة
Formation Number	4416116	رقم التأسيس
Company Address Business Centre, Sharjah Publishing City Free Zone, Sharjah, United Arab Emirates		عنوان الشركة مركز الأعمال، مدينة الشارقة للنشر- المنطقة الحرة، الشارقة، الإمارات العربية المتحدة
License Formation Date	15/10/2024	تاريخ تأسيس الرخصة
License Expiry Date	14/10/2026	تاريخ الانتهاء
Manager(s) Hussam Kassab		المدير (المديرون) حسام قصاب
Activity(s) Activities of graphic designers	Code 7410.03	النشاط (الأنشطة) أنشطة مصممي الرسومات



وثيقة إلكترونية معتمدة صادرة دون توقيع من مدينة الشارقة للنشر - هيئة منطقة حرة. للتحقق من صحة هذه الوثيقة يرجى مسح رمز الاستجابة السريع أو زيارة الرابط:

Approved electronic document issued without signature by Sharjah Publishing City - Free Zone Authority. To verify this document kindly scan the QR Code or visit:

<https://portal.spcfz.ae/web/mydocuments/dc/176277314987?d=TIRFNU1UZz0=>

Issued by Sharjah Publishing City - Free Zone Authority and subject to all laws, regulations, rules and policy that are issued by the authority.



صادرة عن مدينة الشارقة للنشر - هيئة منطقة حرة وتخضع لكافة القوانين والأنظمة واللوائح التي تخص الهيئة.

Any alteration or change will void this document.
03.001.02.4416116.01

Page 1 of 1

أي تعديل أو تغيير على هذه الوثيقة يجعلها باطلة.



شهادة تسجيل ضريبة الشركات في الإمارات العربية المتحدة

Certificate of Registration for Corporate Tax in the United Arab Emirates
(as per Federal Decree-Law Number 47 of 2022 on the Taxation of Corporations and Businesses)

The Federal Tax Authority certifies that the entity below is
a registered person for Corporate Tax in the UAE

تشهد الهيئة الاتحادية للضرائب أن الجهة التالية مسجلة لضريبة الشركات في الإمارات العربية
المتحدة

Tax Registration Number	104798853800001	رقم التسجيل الضريبي
Legal Name of Person/Entity (Arabic)	أدفانسد لاستشارات الحلول الهندسية ش م ح	الاسم القانوني للشخص / الكيان (باللغة العربية)
Legal Name of Person/Entity (English)	Advanced Engineering Solutions Consultancy FZC	الاسم القانوني للشخص / الكيان (باللغة الانجليزية)
Registered Address, and Contact Number	Business Centre, Sharjah Publishing City Free Zone, Sharjah, Sharjah, Sharjah +971561409403	العنوان المسجل ورقم التواصل
Effective Registration Date	01/10/2024	تاريخ التسجيل الفعلي

Corporate Tax Period

الفترة الضريبية للشركات

Corporate Tax Period	First Corporate Tax Period Start Date/تاريخ ابتداء الفترة الأولى لضريبة الشركات	First Corporate Tax Period End Date/تاريخ انتهاء الفترة الأولى لضريبة الشركات	First Corporate Tax Return Filing Due Date/ أول تاريخ استحقاق لتقديم الإقرار لضريبة الشركات	الفترة الضريبية للشركات
1 January - December	01/10/2024	31/12/2025	30/09/2026	يناير - ديسمبر

**List of sole establishments and branches under the
registered taxable person:**

قائمة المؤسسات الفردية والفروع المندرجة ضمن التسجيل الضريبي:

Legal Name	Licensing Authority	License Number/رقم الرخصة	جهة الترخيص	الاسم القانوني
------------	---------------------	---------------------------	-------------	----------------

Date of Issue

27/12/2024

تاريخ الاصدار





Legal Name	Licensing Authority	License Number/رقم الرخصة	جهة الترخيص	الاسم القانوني
1 Advanced Engineering Solutions Consultancy FZC	Sharjah Publishing City	4416116.01	مدينة الشارقة للنشر	أدفانسد لاستشارات الحلول الهندسية ش م ح

***Please check that the details on this certificate are correct. You must inform the Federal Tax Authority of any change on the basis of which you obtained your Tax Registration Number.**

يرجى التأكد من صحة تفاصيل الشهادة. يجب إبلاغ الهيئة الاتحادية للضرائب في حال تغيير الأسس التي حصلت فيها على رقم التسجيل الضريبي الخاص بك.*





شهادة التسجيل في ضريبة القيمة المضافة
أصدرت بموجب الصلاحية الممنوحة بموجب المادة (4) من المرسوم بقانون رقم (13) لسنة 2016 بشأن إنشاء الهيئة الاتحادية للضرائب

Certificate of Registration for Value Added Tax in the United Arab Emirates
Issued under the authority allocated by Art. 4 of the Federal Decree-Law No. 13 of 2016

The Federal Tax Authority certifies that the entity below is
a registered person for Value Added Tax in the UAE

تشهد الهيئة الاتحادية للضرائب أن الجهة التالية مسجلة لضريبة القيمة المضافة في الإمارات العربية
المتحدة

Tax Registration Number	104798853800003	رقم التسجيل الضريبي
Legal Name of Entity (Arabic)	أدفانسد لاستشارات الحلول الهندسية ش م ح	الاسم القانوني للكيان (باللغة العربية)
Legal Name of Entity (English)	Advanced Engineering Solutions Consultancy FZC	الاسم القانوني للكيان (باللغة الانجليزية)
The Registered Address and Contact Number	Business Centre, Sharjah Publishing City Free Zone, Sharjah, Sharjah, Sharjah +971561409403	العنوان المسجل ورقم التواصل
Effective Registration Date	01/06/2025	تاريخ التسجيل الفعلي
First VAT Return Period	01/06/2025 - 31/08/2025	فترة أول إقرار لضريبة القيمة المضافة
VAT Return due date	29/09/2025	تاريخ استحقاق الإقرار الضريبي لضريبة القيمة المضافة
Start and end dates of Tax periods	1st Mar to 31st May, 1st June to 31st Aug, 1st Sep to 30th Nov, 1st Dec to 28th Feb	تواريخ بدء وانتهاء الفترات الضريبية

List of Main trade license, Sole Establishments and branches
licenses details under the registered taxable person:

قائمة الرخصة التجارية الرئيسية والمؤسسات الفردية والفروع المدرجة ضمن التسجيل الضريبي :

Legal Name	License Issuing Authority	License Number/رقم الرخصة	جهة الترخيص	الاسم القانوني
------------	---------------------------	---------------------------	-------------	----------------

يرجى التأكد من صحة تفاصيل الشهادة. يجب إبلاغ الهيئة الاتحادية للضرائب في حال تغيير الأسس التي حصلت فيها على رقم التسجيل الضريبي
الخاص بك.*

*Please check that the details on this certificate are correct. You must inform the Federal Tax Authority of any change on
the basis of which you obtained your Tax Registration Number.

Date of Issue

27/05/2025

تاريخ الاصدار





Legal Name	License Issuing Authority	License Number/رقم الرخصة	جهة الترخيص	الاسم القانوني
1 Advanced Engineering Solutions Consultancy FZC	Sharjah Publishing City	4416116.01	مدينة الشارقة للنشر	أدفانسد لاستشارات الحلول الهندسية ش م ح

يرجى التأكد من صحة تفاصيل الشهادة. يجب إبلاغ الهيئة الاتحادية للضرائب في حال تغيير الأسس التي حصلت فيها على رقم التسجيل الضريبي الخاص بك.*

***Please check that the details on this certificate are correct. You must inform the Federal Tax Authority of any change on the basis of which you obtained your Tax Registration Number.**

Date of Issue

27/05/2025

تاريخ الاصدار





URSP Certification Services
Lot 39&41 Blk. 6 P1 Lavanya Subd.,
Gen. Trias City, Cavite, 4107 Philippines
T: +63464246869 M: +639399301875
E: urs.philippines@gmail.com

LETTER OF CONFIRMATION

This is to confirm that

AESP Architectural & Engineering Services Affiliated with Advanced Engineering Solutions (AES)

Office Address: Dr. 9, 722 Metropolis
Tower, Lacson St., Mandalagan, Bacolod
City, 6100 Philippines

has been approved for the scope

Provisions of Architectural and Engineering Services

ISO 9001:2015

Approved Program with No.: **120866/A/0001/UK/En**

After completion of the stage 2 audit, Technical review of the audit report will be performed by the certification office and for posting of the final review result and recommendation.

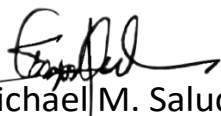
Michael M. Salud
General Manager





Certificate of Registration

This is to certify that the

QUALITY MANAGEMENT SYSTEM

of

AESP ARCHITECTURAL ENGINEERING SERVICES

Unit 302-308, AMV Building, No.52, Cr Carmen Ave, Hernaez St., Barangay 40, Bacolod City, Negros Occidental, 6100, PHILIPPINES

for

Provision of Architectural and Engineering Designs

has been assessed and registered against the provisions of

ISO 9001:2015

International Standard

with

Registration Number:	75Q23108	Cycle Start Date:	22 November 2024
Project:	99-23108-1-Q	Approval Date:	22 November 2024
		Issue Date:	22 November 2024
Certification Approved By:		Expiry Date:	22 November 2027
Doug Page-Symonds			
Chief Executive Officer			



This certificate remains the property of GCL International Ltd. Registration is subject to the Scheme Rules, which are published at www.gcl.uk. Any misuse, alteration, forgery, or falsification is considered an unlawful act. Please validate the authenticity of this certificate at www.gcl.uk or by emailing certification@gcl.uk

GCL INTERNATIONAL LTD

Level 1, Devonshire House, One Mayfair Place, Mayfair, London, W1J 8AJ, United Kingdom.



**S/N: 80031920
PIN: 39173118**



AES Singapore

ADVANCED ENGINEERING SOLUTIONS (SG) PTE. LTD.
8 Marina View #39-04 Asia Square Tower 1,
Singapore 018960, Tel: +65 65422309 , +973 38942642.
Email: info@sg-aes.com

AESP Philippines

V5 Building, Office No. 302-308 3rd Floor, Hernaez Cor.
Carmen Street, Bacolod City,
Tel: +63-344458210/+63-9085161509/+63-9457194592.

Middle East

GCC Countries: Contact - +966-542827478
+973-38942642/ +973-32106402 / +973-34007890

Turkey Representatives: Gaziantep – Turkey
Contact - Tel +90 551 587 9600

AES Lebanon: El-Koura – Kafr Aaqqa – Center Mitri
Tel +961-3196240 / +961-6651637/ +961-71814788 /
+961-71062684. Email: info@aes-leb.com

www.aes-global.net

